

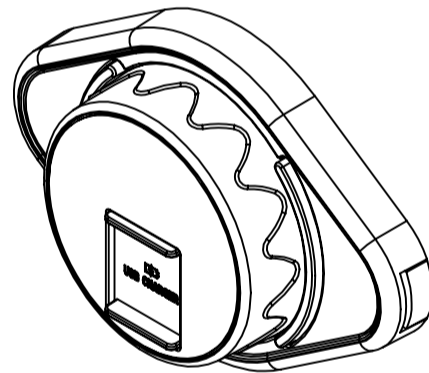

IDEALCHARGE	NAME	DATE	DRAWING TITLE	CLASS	DNY
Drawn			SPECIFICATION OF USB CHARGER	SCALE	X:1
Checked				Unit	MM
Approved			DRAWING NO.	SHEET	1/1

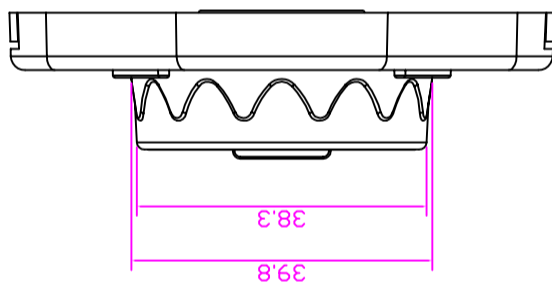
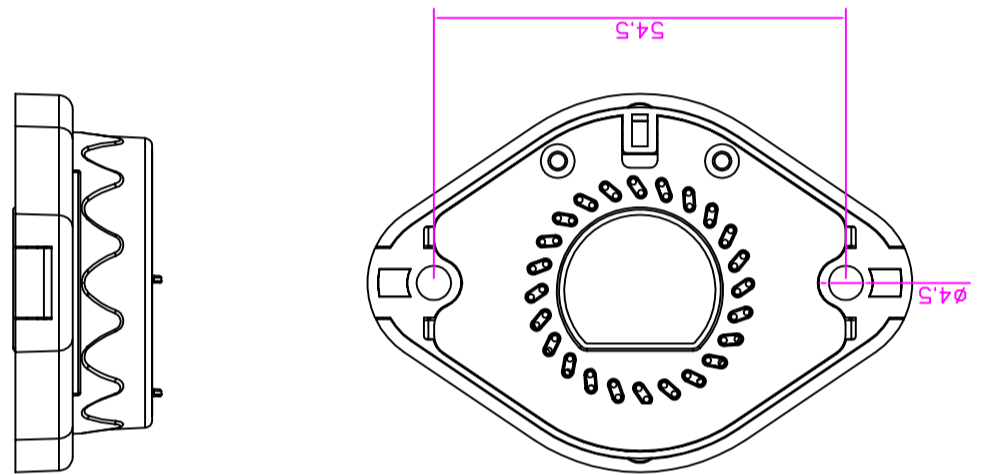
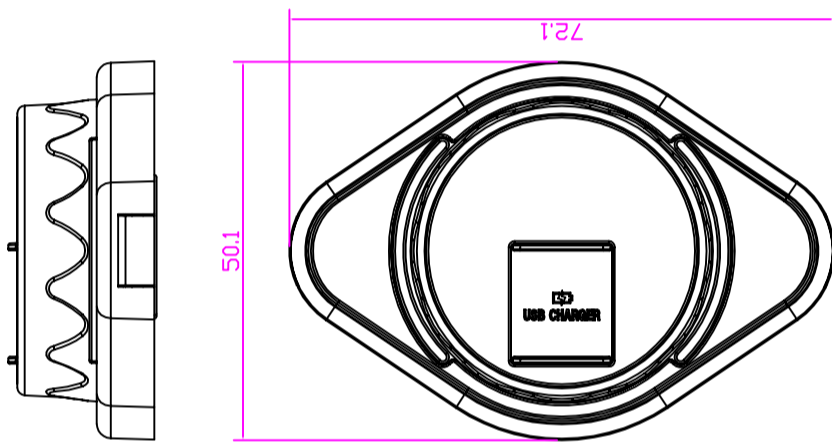
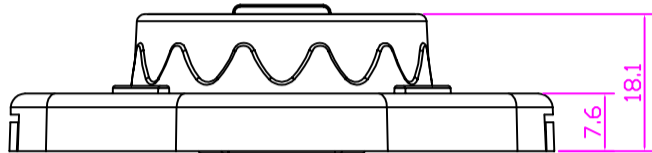

消银龙黑字

2USB
2.4A+2.4A

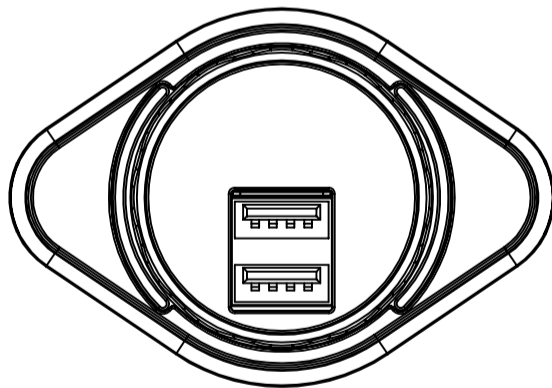

USB+TYPE C
2.4A+2.4A

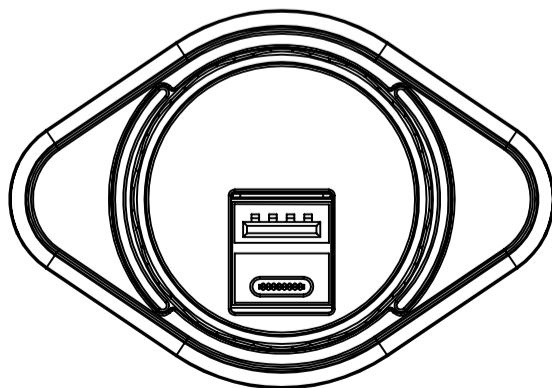

Specification

Working Voltage:DC12-24V

Rate Power: 24W

Output:5VDC 2.4A+2.4A

Working Temperature:-20~70°C

3100mA output current for mobile phones

Charging protection measurers:

Input reverse protection

Output short protection

Too high input voltage protection

Too lower input voltage protection

Too high output current protection

4000V ESD protection

2000V EFT protection

Built-in LED light

Vehicle standard

Suppot charger specification:BC1.2 DCP

Pass: CE/FCC Certificate

Easy-mount USB charger for buses